

GROUP E10 POWER TAKE-OFF (HYDRAULICALLY ACTUATED CLUTCH)

SECTION 5 SPECIFICATIONS

CLUTCH

Type	Wet, multiple disc
Size (O.D. of Facing)	5.250 in.
Total Contact Area	116.250 in.
Drive Plate Thickness	0.065-0.060 in.
Driven Plate Thickness	0.0710-0.0665 in.
Spring Free Length	2.629 in.
Piston Diameter	4.995-4.990 in.
Piston Width	1.781 in.

BRAKE

Plate O.D.	6.125 in.
Plate I.D.	4.687 in.
Plate Thickness	0.187-0.183 in.
Friction Disc O.D.	6.062 in.
Friction Disc I.D.	4.515-4.505 in.
Friction Disc Thickness	0.127-0.122 in.
Piston I.D.	5.005-5.000 in.
Piston Width	2.125 in.
PTO Housing Cone Head Screw Torque	135-150 ft-lbs

OUTPUT SHAFT

	<u>540 RPM</u>	<u>1000 RPM</u>	<u>ENGINE SPEED</u>
Shaft Speed at Engine Speed of 2400 rpm	549 rpm	984 rpm	2400 rpm
Shaft Rotation	Clockwise	Clockwise	Counterclockwise
Shaft Size	1.375 in.	1.375 in.	1.375 in.
Length of Splines	3 in.	2.750 in.	2.750 in.
Number of Splines	6	21	21

SECTION 10 SERVICING

GENERAL

A single speed 540 rpm PTO may be installed on 1755, 1855 and 1955 Tractors. A single speed 1000 rpm PTO or a dual speed 540 and 1000 rpm PTO may be installed on 1755, 1855, 1955 and 2255 Tractors. Engine speed PTO is also included in tractors for use with high speed equipment. If tractor is equipped with single speed 540 rpm PTO, 1000 rpm PTO output shaft and bearing must be purchased to perform engine speed PTO operations.

DO NOT USE 540 RPM PTO WITH IMPLEMENTS REQUIRING 60 OR MORE HORSEPOWER.

Due to high torque required to operate 60 or higher horsepower implement with 540 rpm PTO, telescoping PTO shafts bind and can cause excessive damage. Any implement that requires 60 or more horsepower should be operated by 1000 rpm PTO as torque loads are greatly reduced at higher speed.

OPERATION

PTO clutch and brake are hydraulically actuated. PTO operation is controlled by single spool, closed center valve mounted on PTO housing.

PTO drive shaft is splined to PTO hub attached to engine flywheel. Drive shaft is also splined to PTO drive hub located in PTO clutch assembly.

When control lever is moved to ON position, oil is pressurized at 200 psi from valve through passage in

housing and bearing support to area between clutch piston and brake piston. Clutch piston moves forward compressing clutch plates. When clutch is engaged, torque is transmitted to PTO drive pinion through clutch plates. Drive pinion transmits power directly to engine speed PTO through internal splines at rear of pinion. Pinion transmits power to 540 and 1000 rpm PTO output gears through helical teeth machined in its outer surface. Drive coupling is used to connect 540 rpm output gear or 1000 rpm output gear to output gear shaft. Only one output gear is used in single speed units. Drive coupling is locked on gear hub by retaining ring. Drive coupling locking mechanism, located inside output gear shaft on dual speed units, makes it impossible to shift coupling onto 1000 rpm output gear when 540 rpm PTO output shaft is installed in unit.

When control lever is moved to BRAKE position, oil is pressurized at 200 psi from valve through passage in housing and bearing support to area between brake piston and bearing support. Piston moves forward against brake reaction plate and friction disc applying pressure to brake plate.

When pressure on either clutch or brake piston is reduced, spring in clutch assembly returns pistons to neutral position. PTO control valve spool is detented in ON and BRAKE positions. When tractor engine is shut off while PTO is ON, PTO valve will automatically move out of detent to OFF. However, spool must be manually moved from BRAKE to OFF.

1755-1855-1955-2255 TRACTOR SHOP MANUAL

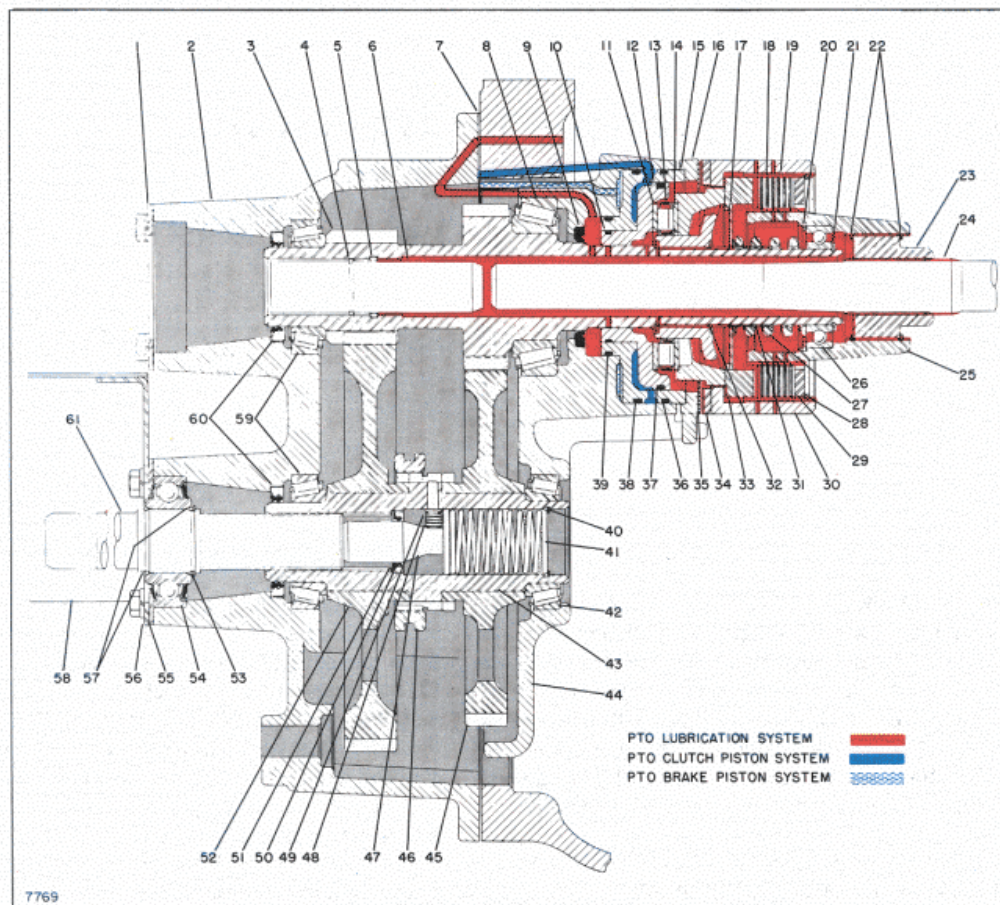

Fig. 1 PTO Cross Section

- | | | |
|---------------------|---------------------------|---------------------------|
| 1. Cover | 22. Snap Ring | 42. Bearing |
| 2. PTO Housing | 23. Clutch Driver Hub | 43. Gear Shaft |
| 3. Pinion | 24. Drive Shaft | 44. Inner Bearing Support |
| 4. Retaining Ring | 25. Clutch Driver | 45. Gear |
| 5. O-Ring | 26. Bearing | 46. Coupling, Retainer |
| 6. Plug | 27. Clutch Spring | 47. Lock Actuating Cam |
| 7. Gasket | 28. Retaining Ring | 48. Lock Pin |
| 8. Bearing | 29. Washer | 49. Lock Spring |
| 9. Seal | 30. Clutch Housing | 50. Cam Seal |
| 10. O-Ring | 31. Spring Guide | 51. Cam Washer |
| 11. Bearing Race | 32. Snap Ring | 52. Gear |
| 12. Clutch Piston | 33. Clutch Collar | 53. Snap Ring |
| 13. Thrust Bearing | 34. Brake Plate | 54. Bearing |
| 14. Bearing Race | 35. Friction Plate, Brake | 55. Bearing Retainer |
| 15. Brake Piston | 36. Quad-Ring | 56. Shield Support |
| 16. Clutch Actuator | 37. O-Ring | 57. Snap Ring |
| 17. Spring Plate | 38. Quad-Ring | 58. Shield |
| 18. Clutch Plate | 39. O-Ring | 59. Bearing |
| 19. Separator Plate | 40. Retaining Ring | 60. Seal |
| 20. Retaining Ring | 41. Return Spring | 61. Shaft |

1755-1855-1955-2255 TRACTOR SHOP MANUAL

DESIGN IMPROVEMENTS

On 1755, 1855 and 1955 Tractors, a polished seal surface area was added to PTO shaft with incorporation of transmission input shaft nut and seal assembly.

Additionally, shaft diameter was decreased where it passes through Over/Under Hydraulic-Shift and transmission input shaft to eliminate possibility of contact between shafts.

LUBRICATION

PTO assembly receives lubrication from transmission and final drive compartment (Fig. 1). Pressurized lubricant supplied by transmission oil pump is directed to PTO clutch. Refer to Operator's Manual for stationary PTO operation lubrication requirement.

DRIVE SHAFT REMOVAL

Remove end plate or engine speed PTO shaft and bearing from housing. Extract drive shaft plug retaining ring. Pull drive shaft plug from pinion with 1/2 - 13 x 7 inch cap screw. Oil trapped in clutch lubrication circuit will flow from pinion bore when plug is removed. Withdraw O-Ring from pinion bore.

DRIVE SHAFT INSTALLATION

Insert drive shaft through drive pinion into hub secured to engine flywheel. Place drive shaft plug O-Ring in forward groove in drive pinion.

Install drive shaft plug being sure projection at rear of plug fits into pinion spline. Insert drive shaft plug retaining ring. Reinstall housing end plate or engine speed shaft and bearing.

PTO ASSEMBLY REMOVAL

Remove PTO drive shaft, drawbar support and control valve linkage. Drain lubricant from transmission and final drive compartment. Support PTO assembly and remove cap screws securing assembly to rear frame. Pull assembly from rear frame.

PTO ASSEMBLY INSTALLATION

Insert PTO assembly into rear frame with dowels in provided holes. Secure assembly to frame with cone head cap screws torqued to specified value. Install remaining cap screws and lock washers. Install drive shaft, drawbar support and control valve linkage.

Fill transmission and final drive compartment with lubricant. Start engine and check PTO operation.

PTO DISASSEMBLY

Remove PTO assembly from tractor. Separate safety shield, bearing retainer, stub shaft and bearing from housing. Remove control valve. See PTO control valve removal, Section 15.

Remove snap ring and remove driver hub. Compress clutch spring and remove snap ring securing clutch driver (Fig. 2). To compress clutch spring, tool may be fabricated as shown in figure 3. Lift out clutch driver, spring and spring guide. Remove snap ring and bearing from driver.

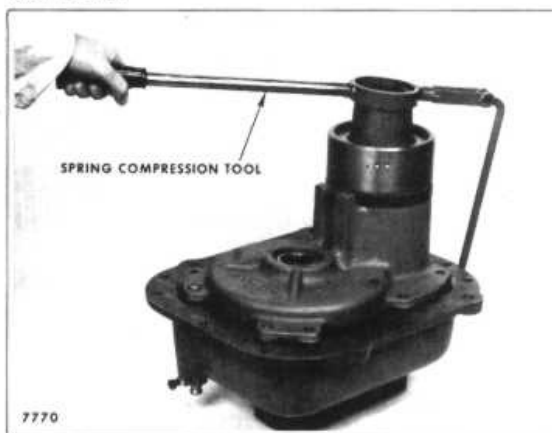

Fig. 2 Compressing PTO Clutch Spring

Take out retaining ring and pull washer, separator plates, clutch plates, collar and spring plate from clutch housing. Remove snap ring and pull clutch housing, clutch actuator, friction plate, brake reaction plate and thrust bearing and races (Fig. 4). Take out six cap screws and

1755-1855-1955-2255 TRACTOR SHOP MANUAL

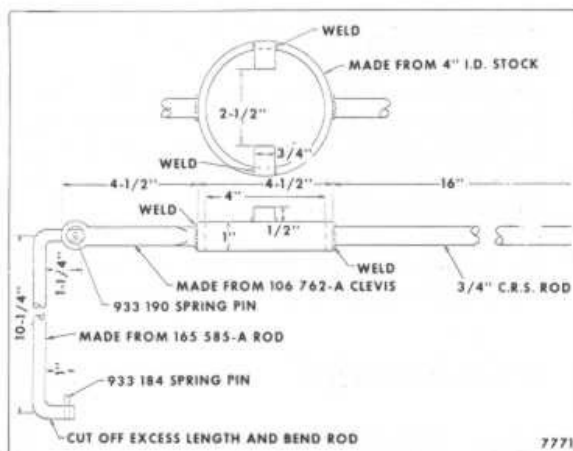

Fig. 3 Spring Compression Tool

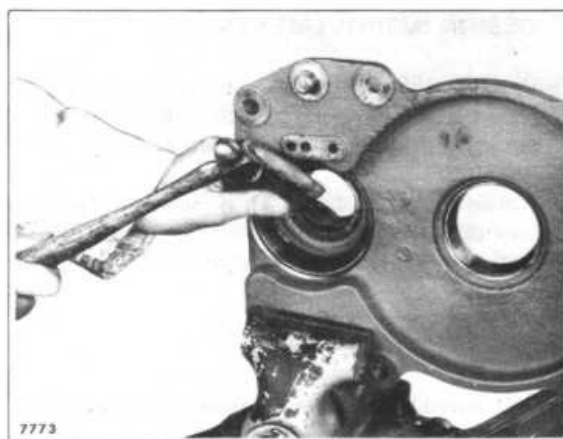

Fig. 5 Removing Clutch And Brake Pistons

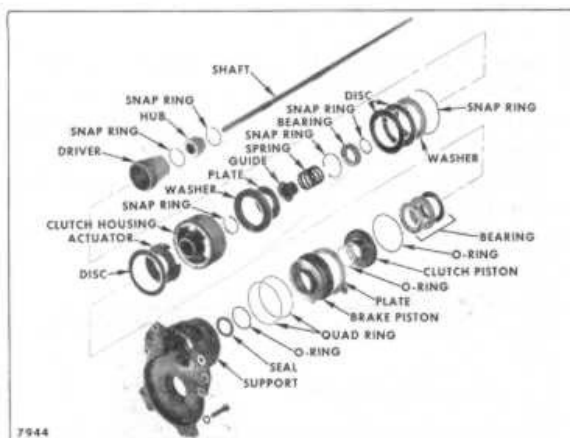

Fig. 4 Clutch And Brake Exploded View

pull inner bearing support from PTO housing. Remove two oil passage O-Rings from between PTO housing and inner bearing support.

Secure bearing support in vice and tap out inner clutch piston and outer brake piston (Fig. 5). Remove O-Rings and quad-rings from pistons and remove pinion seal from inner bearing support. Remove bearing races from support.

Withdraw shifter rod lock screw. Remove output gear or gears and shaft, shifter rod and fork and PTO pinion. Remove bearing races and seals from PTO housing and bearing cones from pinion. Separate bearing cones, output gear or gears, and drive couplings from gear shaft.

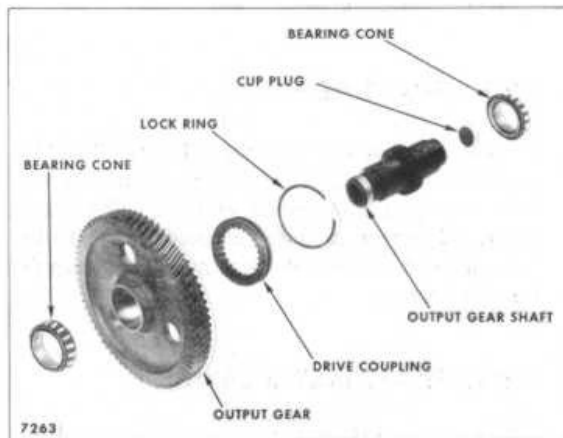

Fig. 6 540 RPM Single Speed Output Gear And Shaft

ON 540 RPM SINGLE SPEED UNITS, remove snap ring from gear shaft drive collar and cup plug from shaft bore. Pull cup plug from shifter rod bore in PTO housing (Fig. 6).

ON 1000 RPM SINGLE SPEED UNITS remove snap ring from gear shaft drive collar. Extract snap ring at front of output shaft bore. Withdraw shifter lock mechanism. Remove lock pin cam seal and alignment washer from shaft bore. Pull cup plug from shifter rod bore in PTO housing (Fig. 7).

ON DUAL SPEED UNITS, remove snap ring at front of output shaft bore. Withdraw shifter lock mechanism. Remove lock pin cam seal and alignment washer from shaft bore. Pull shifter rod seal from PTO housing (Fig. 8).

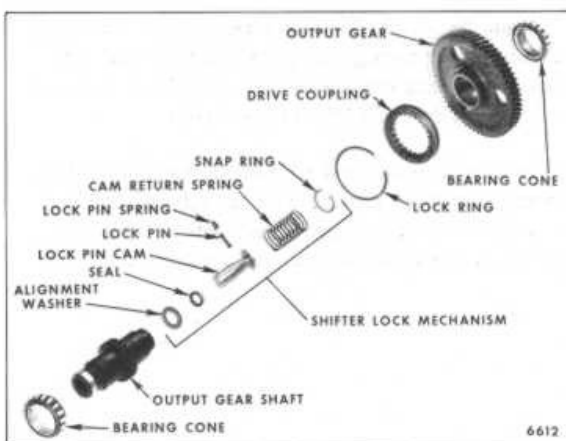

Fig. 7 1000 RPM Single Speed Output Gear And Shaft

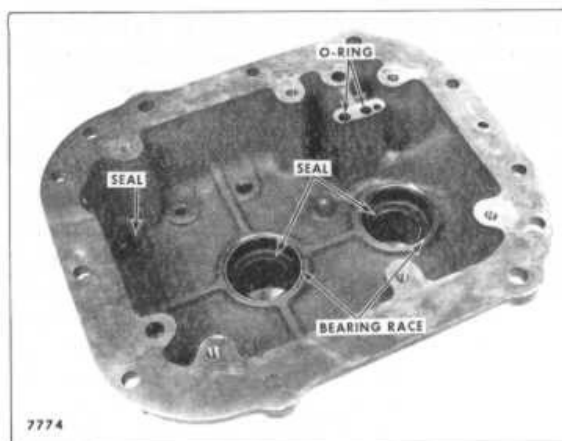

Fig. 9 PTO Housing

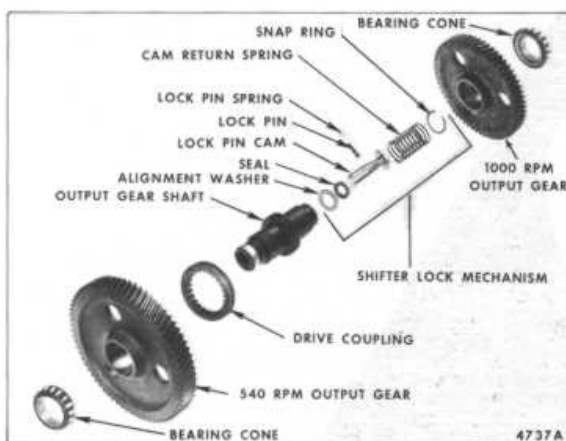

Fig. 8 Dual Speed Output Gears And Shaft

ON 1000 RPM SINGLE SPEED UNITS, install new cup plug in shifter rod bore in PTO housing with cupped side forward.

Insert alignment washer and cam seal into output gear shaft (Fig. 7). Install lock pin and spring. Push lock pin against spring and slide lock cam into output shaft. Install cam return spring and snap ring. Place snap ring into groove in output shaft drive collar. Position drive coupling on output gear hub. Slide gear onto output shaft so that it is in front of gear shaft drive collar and drive coupling contacts both gear hub and drive collar. Install output gear shaft bearing cones.

ON DUAL SPEED UNITS, install shifter rod seal in PTO housing with sealing lip forward. Install lock mechanism cam seal in output gear shaft bore with sealing lip forward (Fig. 8). Install lock pin and spring. Push lock pin against spring and slide lock cam into output shaft. Insert cam return spring and snap ring. Position 1000 rpm output gear on front of gear shaft and secure with bearing cone. Install drive coupling on shaft drive collar and 1000 rpm gear hub. Locate 540 rpm output gear on rear of shaft and secure with bearing cone.

PTO ASSEMBLY

Install new tapered bearing races in PTO housing and inner bearing support. Install new seals in PTO housing with sealing lip forward (Fig. 9).

ON 540 SINGLE SPEED UNITS, install new cup plug in shifter rod bore in PTO housing with cupped side forward. Insert new cup plug in gear shaft bore with cupped side forward.

Install lock ring on gear shaft drive collar. Position drive coupling on output gear hub. Slide gear onto gear shaft so that drive coupling contacts both gear hub and gear shaft drive collar. Output gear must be located behind drive collar. Install output gear shaft bearing cones (Fig. 4).

Position output shaft assembly and shifter rod and fork, if equipped, in PTO housing. Install bearing cones on PTO pinion and place pinion in PTO housing so pinion teeth mesh with output gear teeth.

Install new pinion seal in inner bearing support with sealing lip forward. Install new O-Ring and quad-ring seals on clutch and brake pistons. Lubricate pistons with number 210 Lubriplate. Push pistons together and push

1755-1855-1955-2255 TRACTOR SHOP MANUAL

piston assembly into inner bearing support. Place new oil passage O-Rings on PTO housing, install inner bearing support on housing, align with locating dowels and secure assembly with six cap screws and lock washers.

Install thrust bearing and races. Insert brake actuator plate with flat side up and lug in provided recess in bearing support. Install friction plate and actuator. Attach clutch housing and secure with snap ring. Insert clutch collar, spring plate, spring guide and spring.

Put bearing in clutch driver and secure with snap ring. Place driver over spring, compress assembly and secure with snap ring. Snap ring has flat side and slightly rounded side—**FLAT SIDE MUST FACE FORWARD.**

Position seven external and six internal lug clutch plates alternately on driver starting with an external lug plate. Place washer over plates and fasten with retaining ring. Put driven hub in clutch drive and secure snap ring.



YOU + CORRECT WORK HABITS = SAFETY

SECTION 15 PTO CONTROL VALVE

GENERAL

A single spool, closed center valve controls hydraulic pressure applied to PTO clutch and brake pistons. Valve is mounted on PTO housing and is connected to control lever by mechanical linkage.

OPERATION

PTO system uses oil supplied from tractor hydraulic system (Fig. 1). Oil flow is from hydraulic reservoir through hydraulic filter, hydraulic pump and pressure reducing valve to PTO control valve inlet port. Pressure reducing valve maintains oil pressure in circuit to PTO control valve at 200 psi. With closed center system, there is no oil flow through valve in neutral position.

Moving spool upward or to "ON" position opens valve pressure port to clutch piston and pressure control sleeve. As pressure starts to build in clutch circuit, pressure control sleeve moves against spring and allows some oil to flow through return passage back to reservoir. As spool is moved further toward fully engaged position pressure increases and pressure control spring compresses further, until at fully engaged position pressure control sleeve has completely shut off any oil flow to reservoir and clutch circuit is pressurized at full 200 psi pressure. At full travel, spool is in detent and holds PTO clutch in engaged position. To disengage PTO clutch, manually return spool to neutral. When tractor engine is shut off, spool will automatically return to neutral.

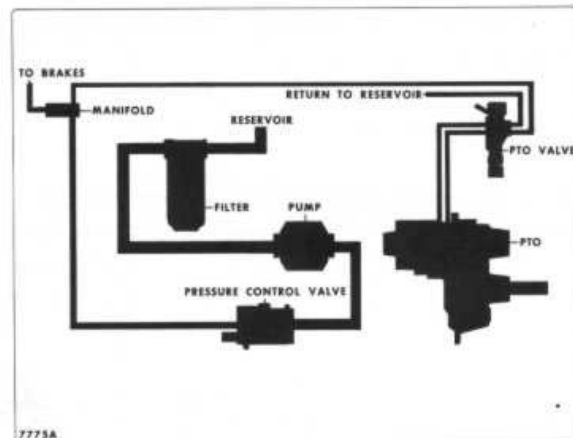

Fig. 1 PTO System Schematic

Moving valve spool downward or to "Stop" position opens valve pressure port allowing oil flow to clutch brake piston and closes return port preventing oil flow to reservoir. Full oil pressure is immediately applied to brake piston. Spool is in detent position and must be returned to neutral by hand.

VALVE REMOVAL

Disconnect linkage from control lever and disconnect input and return oil lines. Remove two cap screws and lift valve from PTO housing being careful not to drop detent ball. Remove detent spring and three O-Ring seals.

VALVE INSTALLATION

Place detent spring in provided location in PTO housing. Position detent ball and three O-Ring seals in valve and align valve on PTO housing. Secure valve with two cap screws and lock washers. Attach control valve linkage and inlet and return oil lines.

VALVE DISASSEMBLY

Lift valve cap, drive spring pin from bell crank, pull bell crank from valve housing and pull out linkage arm.

Take out valve body plug and remove O-Ring from plug. Pull spool out from bottom of valve body. Remove O-Ring seal at top of body.

Compress return spring, remove snap ring, spring and two washers. Compress pressure control spring; remove snap ring, spring, sleeve stop, two washers and pressure control sleeve (Fig. 2).

VALVE ASSEMBLY

Slide pressure control sleeve on spool with flattened sides toward top of spool. Insert washer, pressure control

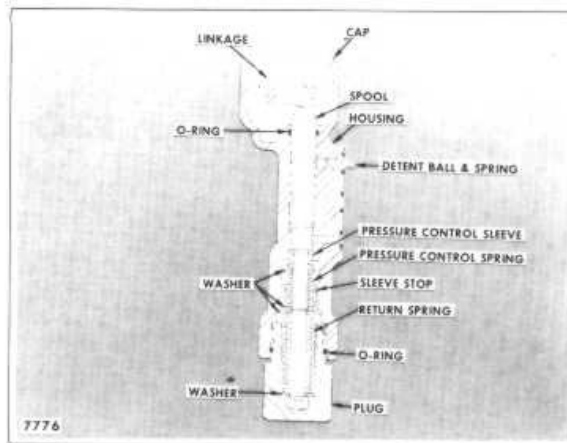

Fig. 2 PTO Valve Cross Section

spring, sleeve stop, washer and secure with snap ring. Install large washer, return spring, washer and snap ring. Insert O-Ring at top of valve body. Lubricate spool and slide into valve body from bottom. Install O-Ring on body plug and install plug in body. Insert linkage arm so pin engages spool, insert bell crank and secure with spring pin. Install valve cap (Fig. 2). Attach valve to PTO and hook up linkage.



WORK SAFELY